

# JT EATON™

# 4 the Birds®

## TRANSPARENT

# Bird Repellent

## *Gel & Liquid*

How to Reduce  
the Problems  
Caused by  
Nuisance Birds



#666  
10 Fl. Oz.  
GEL



#688  
5 Gallon  
LIQUID

#677  
One Gallon  
LIQUID

# TECHNICAL MANUAL

## JT EATON™

J. T. EATON & CO., INC.  
1393 East Highland Road  
Twinsburg, OH 44087 U.S.A.  
330.425.7801

**800.321.3421**  
FAX 330.425.8353  
www.jteaton.com

# JT EATON™

## 4 the Birds® TRANSPARENT Bird Repellent Liquid or Gel

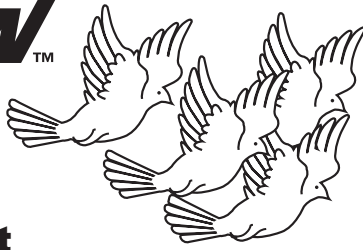

# KEEPS NUISANCE BIRDS FLYING



## Why Effective Bird Control Is Important

More than 60 transmittable diseases (some of which are fatal) are carried and transmitted by birds to humans. For example:

- **HISTOPLASMOSIS** is a respiratory disease that may be fatal. It results from a fungus growing in dried bird droppings.
- **CANDIDIASIS** is a yeast or fungus infection spread by pigeons. The disease affects the skin, the mouth, the respiratory system, the intestines and the urogenital tract, especially the vagina. It is a growing problem for women, causing itching, pain and discharge.
- **CRYPTOCOCCOSIS** is caused by a yeast found in the intestinal tract of pigeons and starlings. The illness often begins in humans as a pulmonary disease and may later affect the central nervous system. Since attics, cupolas, ledges, schools, offices, warehouses, mills, barns, park buildings, signs, etc. are typical roosting and nesting sites, the fungus is apt to be found in these areas.

- **ST. LOUIS ENCEPHALITIS**, an inflammation of the nervous system, usually causes drowsiness, headache and fever. It may even result in paralysis, coma or death. St. Louis encephalitis occurs in all age groups, but is especially fatal to persons over age 60. The disease is spread by mosquitoes which have fed on infected house sparrows, and pigeons carrying the Group B virus responsible for St. Louis encephalitis.

- **SALMONELLOSIS** often occurs as "food poisoning". The disease bacteria are found in bird droppings; dust from droppings can be sucked through ventilators and air conditioners, contaminating food and cooking surfaces in restaurants, homes and food processing plants.

*Besides being direct carriers of disease, nuisance birds are frequently associated with over 50 kinds of ectoparasites, which can work their way throughout structures to infest and bite humans. About two-thirds of these pests may be detrimental to the general health and well-being of humans and domestic animals. The rest are considered nuisance or incidental pests.*

A few examples of ectoparasites include:

- **BED BUGS** (*Cimex lectularius*) may consume up to five times their own weight in blood drawn from hosts which include humans and some domestic animals. In an extreme condition, victims may become weak and anemic. Nuisance birds are known to carry bed bugs.
- **CHICKEN MITES** (*Dermanyssus gallinae*) are known carriers of encephalitis and may also cause fowl mite dermatitis and acariasis. While they subsist on blood drawn from a variety of birds, they may also attack humans. Nuisance birds are known carriers.
- **YELLOW MEALWORMS** (*Tenebrio molitor*), perhaps the most common beetle parasites of people in the United States, live in pigeon nests. It is found in grain or grain products, often winding up in breakfast cereals, and may cause intestinal cantharidiasis and hymenolepiasis.

## Methods of Bird Control

Visuals, like balloons, flags, revolving lights, scarecrows and replicas of hawks and owls, are ineffective. In fact, birds have been known to construct nests on the devices.

Mechanical repellents such as strips of non-rusting base bars with stainless steel barbs (also known as "porcupine wires") along building ledges and window sills, often are more of a headache to humans than birds, which often use the needles as nesting locations after a layer of leaves, sticks or straw has accumulated. Electrical repellents, like electrical fences used for livestock, are expensive and are subject to short-circuiting by straw or sticks dropped by birds.

Noise from alarms, speakers, recordings, gas cannons or pyrotechnics (fireworks) are often more offensive to humans because of the proximity of the devices to people living or working nearby.

Birds, on the other hand, become accustomed to the sounds, thereby rendering the devices virtually useless.

Firearms are not only expensive, but high-risk items that are extremely unsafe in the hands of untrained or unskilled users.

Bird populations may be reduced through the use of poisons. However, poisons may accidentally kill birds protected by law.

Trapping is time-consuming, expensive and impractical where large numbers of birds are involved. Considerable time must be spent prebaiting, setting and checking traps, and operational costs may be rather exorbitant because they include staff salaries and cost of equipment.

# What is "4 THE BIRDS"<sup>®</sup> Bird Repellent-Gel



**4 THE BIRDS<sup>®</sup>** is a transparent compound which is applied to places where pigeons and starlings rest, roost or nest.

**4 THE BIRDS<sup>®</sup>** contains polybutene which is used in chewing gum, surgical bandages and lipstick and will not kill birds when used according to package directions.

Also, because of its unique chemical formulation, **4 THE BIRDS<sup>®</sup>** will retain its effectiveness for up to one year (under most weather conditions).

Therefore, birds learn to avoid areas treated with **4 THE BIRDS<sup>®</sup>** and seek new locations for roosting.

Many pest control experts recommend **4 THE BIRDS<sup>®</sup>** as *the best way* to solve pest bird problems.

## How and Where to Use 4 THE BIRDS<sup>®</sup> Gel

**4 THE BIRDS<sup>®</sup>** gel bird repellent is applied with a standard caulking gun. Before inserting a cartridge of

**4 THE BIRDS<sup>®</sup>** into the caulking gun carriageway, simply trim the end of the plastic spout to a taper. Leave the lip on the spout for replacing the cap on partially filled cartridges, and puncture the seal.

*Always remember to replace the cap on the tip of any partially filled caulk tube.*

To apply **4 THE BIRDS<sup>®</sup>**, keep the tapered, flat section of the cartridge spout upper-most, but resting lightly on the surface to be treated. Then, draw the caulking gun slowly towards you while applying steady pressure on the trigger during the full distance of travel.

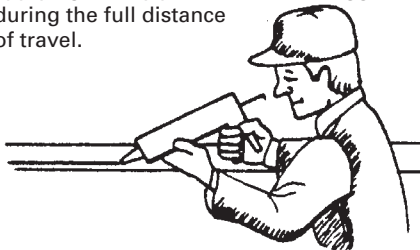

This technique provides a solid bead (strip) of **4 THE BIRDS<sup>®</sup>** repellent approximately 1/2" wide and ensures satisfactory results.

Don't waste **4 THE BIRDS<sup>®</sup>** with haphazard applications. **Instead, be systematic:**



- Clean surfaces before application; remove dead birds, nests, etc., then wire brush or scrape the surface to remove dust, dirt, loose paint, droppings, etc. Wearing rubber or other nonporous gloves and the use of a respirator is recommended. On porous surfaces, such as stone or unpainted wood, the surface should be sealed prior to **4 THE BIRDS<sup>®</sup>** application; brush or spray on a coat of shellac or a 50% solution of white glue, then allow to dry. The use of drop cloths to protect areas below applications is highly recommended.

- Treat all the landing places on the entire building for best results.

**ON NARROW SURFACES**, such as rain gutters, roof peaks, ornamental trim, rose windows, portholes or column caps, generally one 1/2" bead (strip) is enough;

**ON WIDER SURFACES**, such as eaves, chimneys, downspouts, dormers, bell towers, fire walls (parapets), electrical signs and related structures, I-beams and braces, air conditioner and heating ducts, additional beads may be needed. Furthermore, some birds tend to overshoot their intended landing spots requiring additional strips of repellent. To be effective in these situations, apply **4 THE BIRDS<sup>®</sup>** as follows:

**a. Surfaces four inches wide or less**, apply a 1/2" inch diameter bead approximately 1" in from the outside edge.

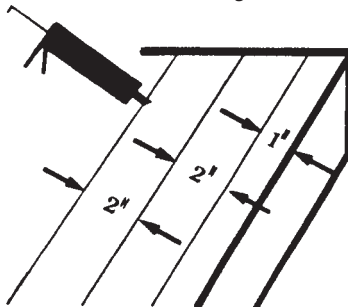

**b. Surfaces four to eight inches wide**, apply two beads about 2" apart, with the first bead 1" in from the edge and the second bead located about 2" in from the first, (3" in from the outside edge).

**c. Wider surfaces**, apply three beads, with the third bead located about 2" in from the second (5" in from the outside edge).

- **BALCONIES** - Where the tops of railings require bird-proofing, first protect the railing by covering with cloth tape; then apply **4 THE BIRDS<sup>®</sup>** over the tape. Also treat floors of balconies beneath railings 1" in from the outside edge. Be sure to caution residents to stay clear of treated areas. Remove the tape from the railing after the birds no longer return to the area and remove any adhesive residue left by tape.

- **MONUMENTS AND OTHER CURVED SURFACES** - Apply where birds have been roosting or are likely to roost.

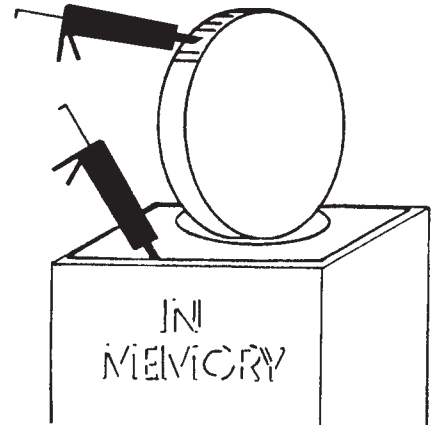

- **CHIMNEYS** - Apply **4 THE BIRDS<sup>®</sup>** along the outside edge of the chimney cap and along the flashing where the chimney joins the roof, a place where birds nest and seek warmth and shade. On the chimney cap, apply a single bead 1" in from the outside edge.

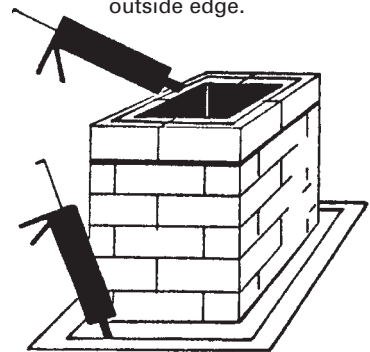

**GUTTERS, GUTTER BOXES, DOWNSPOUTS** - When birds nest in these areas, they clog the natural flow of water. This often results in expensive roof and interior water damage.

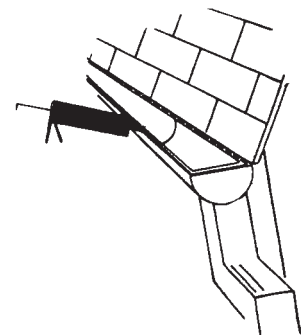

Treat the outermost tip of gutters, laying a continuous 1/2" bead the full length of the gutter. There should be breaks in the bead to allow water to flow into the gutters. Downspout curves under roof overhangs are occasionally the sites of nests and concentrated droppings. In order to treat the area properly, it is important to remove all nests and clean the surface before making application of **4 THE BIRDS®**. After this has been done, apply two beads, beginning 1" in from each outside edge.

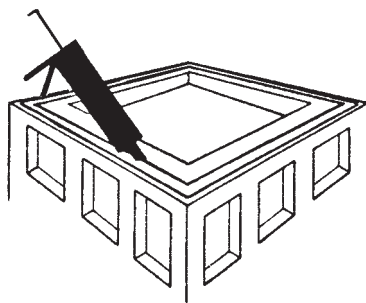

inches wide, apply **4 THE BIRDS®** in two parallel beads 2" apart, beginning approximately 1" in from the outside edge; on wider parapets, apply three beads 2" apart, beginning 1" in from the outside edge.

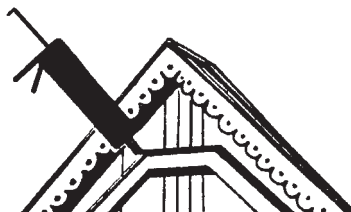

#### PITCHED ROOF RIDGES, EAVES, DORMERS -

In the cases of pitched roofs, treat the entire length of the roof ridges (including eaves and dormers) with at least one continuous bead of **4 THE BIRDS®**. Don't forget to treat the flashing where eaves and dormers join the roof. Lay a series of broken beads 2" to 3" apart. Protrusions, if any, under the eaves of a dormer require treatment because birds build nests in these sheltered areas.

#### BELL TOWERS & STEEPLES -

Although they vary in shape and size, these areas are treated like any other pitched areas of buildings. Steeplejacks can be hired on an hourly basis to work on ridges and other normally inaccessible areas where rigging and ladders cannot be used.

If gutters surround the tower, remove nests and debris and treat the gutters and tops of downspouts.

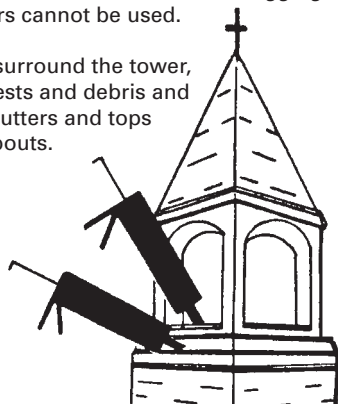

Screening in front of bell tower openings may be required after **4 THE BIRDS®** application, since birds will not alight on treated areas, but instead may seek shelter inside the bell tower itself.

#### PARAPETS OR FIREWALLS -

Usually capped with stone, tile, asphalt, shingles, wood, tar, metal, etc., a parapet is the extension of a wall above the roof line of a structure. On parapets four inches wide or less, apply one 1/2" bead of **4 THE BIRDS®** approximately 1" in from the outside edge; on parapets four to eight

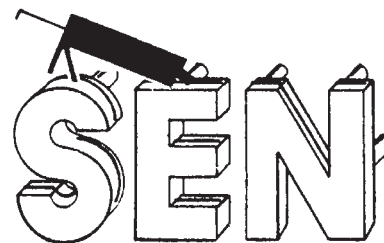

To calculate the amount of **4 THE BIRDS®** required to treat a sign, measure the lineal footage from one end of the sign to the other, and multiply by three for estimating purposes.

**Don't forget to add rods, pins, or structural steel frameworks that support the letters for applying 4 the Birds®.**

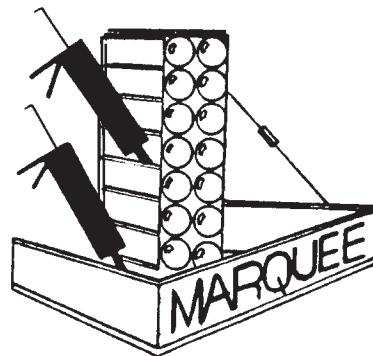

#### SIGNS, MARQUEES, SUBSTRUCTURES & LETTERS -

Be sure all electrical current is turned off before attempting to apply **4 THE BIRDS®** to lighted signs. Tar flashing, as well as the rest of the deck, may have to be cleaned thoroughly prior to application (this should be considered a billable expense). Apply **4 THE BIRDS®** to all supporting beams and braces above and below the sign or marquee; the number of beads (strips) will depend on both the severity of the bird problem and the width of the surfaces.

It may be helpful to have representatives from the sign service company present during application to ensure that **4 THE BIRDS®** is not applied where personnel will be walking.

**COLUMN CAPS-** Apply **4 THE BIRDS®** in 1/2" beads approximately 1" in from the outside edge of the cap and all areas adjacent to it, wherever evidence of birds is found. Remember, besides being functional, columns and caps are often designed to be attractive; therefore, neatness and attention to detail are both important considerations!

#### ORNAMENTAL TRIM (i.e. "ginger-bread") -

Be sure to clean all droppings from the ornamental trim before applying "**4 THE BIRDS®**" to all landing and nesting areas. Remember also that in order to retain the beauty of ornamental trim, it is imperative to be as neat as possible. Since ornamental trim is usually narrow, simply apply one 1/2" bead of **4 THE BIRDS®** to surfaces where birds land.

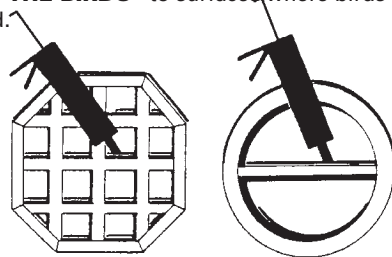

#### ROSE WINDOWS, PORTHOLES -

Since birds do not roost on vertical surfaces, it is only necessary to treat the horizontal roosting areas of rose windows with **4 THE BIRDS®**. Generally, one 1/2" bead along the edges is enough. Wider ledges may require two or more beads. Treat portholes in the same manner as rose windows. If there is a cornice wide enough to serve as a landing site for birds, it should also be treated. HINT: Pay extra careful attention to church rose windows when applying **4 THE BIRDS®**. These windows are extremely expensive to replace and are considered works of art.

**LETTERING -** Birds are likely to roost and build nests in these areas, found on the fronts and sides of buildings where letters have been mounted to spell out the company's name. Bird droppings make the signs and areas around them unsightly.

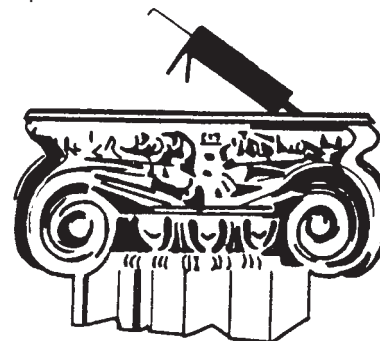

## SPECIFIC EXAMPLES

### SPECIAL INDOOR APPLICATIONS

Follow the suggestions itemized on the previous pages to apply **4 THE BIRDS®** on natural roosting areas such as interior beams, conduits, light fixtures, joists, pipes, etc., wherever birds are roosting.

### BEAMS, BRACES & STEEL STRUCTURES -

Structural steel appears at many outdoor and indoor locations including aircraft hangars, loading docks, amusement park decks, race track decks, plant interiors, etc. Birds frequently roost in these areas.

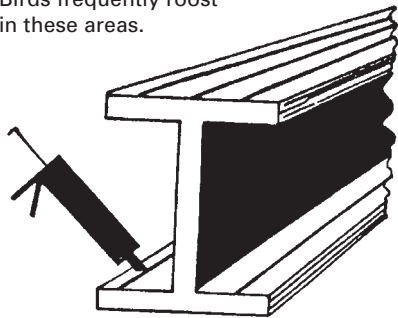

Applicators may, in some instances, be able to apply **4 THE BIRDS®** by walking along beams and braces with the caulking gun in hand and laying as many beads (strips) as necessary. Movable cranes and lift hoists are helpful where available. In other situations, ladders and additional equipment will facilitate application.

When treating I-beams, apply **4 THE BIRDS®** to all four lips in areas of high bird concentration. The actual number of beads of **4 THE BIRDS®** required will be determined by the severity of the bird problem.

Apply a single continuous bead along each inside lip of structural steel or I-beam where nuisance bird problems are not intense; otherwise, lay additional beads of **4 THE BIRDS®**.

## How to Calculate Your Needs

**4 THE BIRDS®**, in easy-to-handle, 10 fluid ounce cartridges that fit any standard caulking gun, is a handy way to treat large areas, even an entire building. Determine how many cartridges of **4 THE BIRDS®** will be needed prior to application by dividing the total number of linear feet to be treated by 10 (each cartridge will treat 10 feet). One shipping case of **4 THE BIRDS®** contains 12 cartridges, enough to lay a bead (strip) 120 feet long.

**4 THE BIRDS®** works in hot, cold and moderate temperatures. It retains its tack from a frosty 15°F to a blistering 200°F.

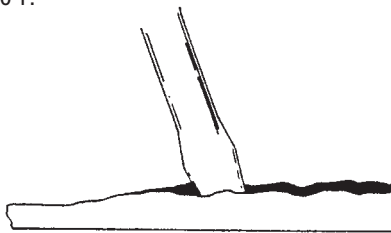

If crust develops on **4 THE BIRDS®** after it has been applied in an excessively dusty area, simply score it with a screw-driver, putty knife or similar instrument to renew the surface for extended effective bird control. Where large numbers of nests have been removed, check newly treated areas frequently for signs of returning birds.

**Please Read All Label Instructions before using this product.**

## What is 4 THE BIRDS® Bird Repellent Liquid



**4 THE BIRDS®** liquid is a similar product to **4 THE BIRDS®** gel. Although it is an opaque white material when first applied it rapidly dries to a transparent colorless film. This liquid formulation of **4 THE BIRDS®** may be sprayed or painted on to various surfaces giving broad coverage compared with the beads resulting from use of the gel.

**Please Read and FOLLOW All Label Instructions before using this product. The label is the law.**

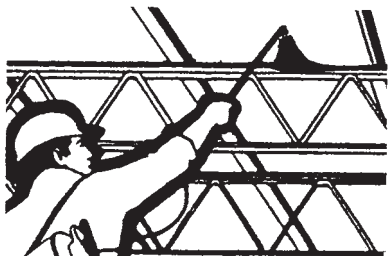

## Surface Preparation for 4 THE BIRDS® Liquid

Clean surfaces to be treated to promote adhesion of this repellent. Wipe or scrape all dust, dirt, droppings or other loose debris from surfaces. Seal porous surfaces prior to treatment by applying one coat (spray on or brush on) of shellac or a 50% solution of white glue and water and allow to dry.

**DO NOT APPLY 4 THE BIRDS® LIQUID to the Exterior of Buildings or Structures.**

## How and Where to Use 4 THE BIRDS® Liquid

**4 THE BIRDS®** liquid may be brushed on to the top surface to be treated or applied by sprayer. Hand pumped sprayers or mechanical equipment may be used with a discharge pressure of 40 to 50 p.s.i. **Do not dilute the liquid.**

The liquid should be thoroughly shaken or mixed prior to use and the surfaces to be treated must be clean, free of dust, and dry.

For interior use, beams, girders, struts, supports, pipes, etc. and anywhere birds may land or roost can be treated.

Machinery, floors, etc. should be covered to prevent spray drift or runoff from falling on them during application.

**4 THE BIRDS®** liquid should be applied as a continuous layer on the top surface of the structure being treated. For larger birds, eg. starlings, more than one application may be necessary to create a thick enough layer for the repellent to be most effective.

**4 THE BIRDS®** liquid may be removed from structural surfaces with mineral spirits, naphtha, or powder type cleaning agents. Spills may be washed off with water if cleaned up immediately. Application equipment should be cleaned with mineral spirits *immediately* after each use.

## FOR EXTERIOR USE

Trees, bushes, shrubs and vines may be treated effectively. **4 THE BIRDS®** liquid should be applied to the point of runoff to the top of all branches large enough to support a bird. Again, cover or otherwise protect all exposed areas not to be treated to avoid spray drift and runoff causing damage.

Do not dilute **4 THE BIRDS®** liquid, use as is after thorough mixing or shaking. Any spray equipment may be used for application with generated pressure up to 150 p.s.i. Aerial application is not permitted.

*It is recommended that treatment to trees, bushes and shrubs be made in the fall or early spring when limbs are bare and easily accessible.* Application to foliage may result in the blocking of respiration and death of the affected foliage might occur. In severe cases the whole plant may die.

**4 THE BIRDS®** contains no toxic materials to plants or animals, but the gel can physically block and prevent respiration. \*Remember that birds rest on the limbs of trees, shrubs, bushes, etc. and need to be sprayed from the top down to be most effective.

Spraying should be done when temperatures are 40°F or above to facilitate drying, and during calm weather to minimize spray drift. *Use a tarp to cover areas where drift and overspray may land.*

## How to Calculate Your Needs of 4 THE BIRDS® Liquid

The amount of coverage you can expect is dependent on the object being treated and the spray equipment.

Generally one gallon of **4 THE BIRDS®** will treat an average tree with a 5" diameter trunk or approximately 6 three-foot high shrubs. One gallon will also cover approximately 25 square square feet of a surface. The approximation should be used only as guidelines.



**JT EATON 4 THE BIRDS®** liquid may be removed with mineral spirits, naphtha or powder type cleaning agents. **Spray equipment should be cleaned with mineral spirits immediately after use.**

**Note:**  
**Do not spray directly on birds. Do not apply 4 THE BIRDS® at locations where the user has concern that desirable birds or protected birds may become entangled in the film. Avoid contamination of food or livestock feed.**

## Some Safety Hints

Although it has been suggested previously, it cannot be emphasized too strongly that safety of the personnel actually applying the repellent is of utmost importance.

- While 12-foot ladders are adequate for many applications, a 40-foot extension ladder should also be readily available.
- Also, 300 feet of 3/4" No. 1 manila rope is recommended for use as a safety line or to secure or hoist ladder extensions. Manila rope is highly recommended because other types may stretch.
- Cornice hooks are also helpful; they should have a 24" gap from tip of hook to shank.
- Use a boatswain's chair in tandem with a block and tackle and a cornice hook for applications where ladders are impractical.
- "Cherry Pickers", in heights from 40 feet to 120 feet, or swing stages, are frequently used in places inaccessible to ladders or for treating wide areas.
- Two kinds of scaffolding are available: where there are level floors, rolling scaffolds are ideal for treating indoor locations such as I-beams, etc., and for up and down movement, power scaffolds which can be erected to any desired height are helpful. To make application safer and faster for your personnel, obtain the following equipment from a safety supply dealer.
- Respirators, rubber (or other non-porous material) gloves, nonskid soled shoes, hard hats, safety glasses or goggles, wire brushes, shovels, brooms, and paint sprayers. Shellac, white glue or silicone solution should also be kept on hand for sealing porous surfaces prior to application. Mineral spirits will be required for clean-up.
- Be sure that your personnel (or those of the outside contractor, if the job is being done in that manner) are adequately insured or covered by Workers' Compensation.
- On occasion, it may be advisable to hire steeplejacks, roofers, window washers, ironworkers, painters, firefighters, etc., to perform some of the application work on very high locations such as steeples and bell tower ridges.

## Some Final Words Of Advice

- Use mineral spirits to clean equipment *immediately* after application has been completed.
- Leave a 1" break in the beads (strips) at least every 10 feet to allow for water drainage (where necessary). In areas of excess rainfall, breaks can be as little as 18" apart.
- Under *most* weather conditions, one treatment of **4 THE BIRDS®** will last up to a year. Areas of heavy bird concentration may require additional applications.
- Wear rubber (or other nonporous material) gloves when removing dead birds, nests or droppings from application sites. Dead birds should be placed in plastic bags for proper disposal.
- To help guard against bird-related diseases, an appropriate respirator recommended by a safety supply house should be used when cleaning the areas to be treated.
- Before applying **4 THE BIRDS®**, inspect the complete structure for roosting areas not obvious from usual vantage points.
- If you have any suggestions about additional uses of **4 THE BIRDS®**, do not hesitate to write or phone. Our staff will gladly consider your information in future **4 THE BIRDS®** publications.

**W**hen estimating a job consider a tube of **4 THE BIRDS®** gel is good for 10 lineal feet. Walk around premise to count number of windows and doors to be treated. This will also give you a rough estimate of roof area, which will help in estimating how much **4 THE BIRDS®** you will need. You can also see if you will require any special equipment, i.e., "cherry pickers", scaffolds, special ladders, etc. With this information you will be able to give a more accurate estimate for the application of **4 THE BIRDS®** gel bird repellent.

# ESTIMATING SHEET



JT EATON & CO., INC.  
 1393 East Highland Road  
 Twinsburg, OH 44087  
 330-425-7801 Fax 330-425-8353  
 800-321-3421 www.jteaton.com

File No. \_\_\_\_\_

Name \_\_\_\_\_ Date \_\_\_\_\_

Address \_\_\_\_\_ Phone \_\_\_\_\_ Fax \_\_\_\_\_

City \_\_\_\_\_ State \_\_\_\_\_ Zip \_\_\_\_\_

Buyer \_\_\_\_\_ Job Location \_\_\_\_\_

Proposed Treatment Area (See reverse for helpful diagrams) \_\_\_\_\_

Running Feet	Number of Cartridges	Treatment Area Time (in hours)	

**Number of Cartridges**

\_\_\_\_\_ @ \$ \_\_\_\_\_ each

**INSURANCE: Worker's Compensation,  
 Public Liability and Property Damage**

**Estimated Costs**

\$ _____	Rental Equipment
\$ _____	Material
\$ _____	Labor
\$ _____	Subtotal
\$ _____	Tax
\$ _____	<b>TOTAL</b>

**ESTIMATED BY** \_\_\_\_\_

# SUGGESTED APPLICATION AREAS

